

ZEDGE MINI

Miniature LED Steplight

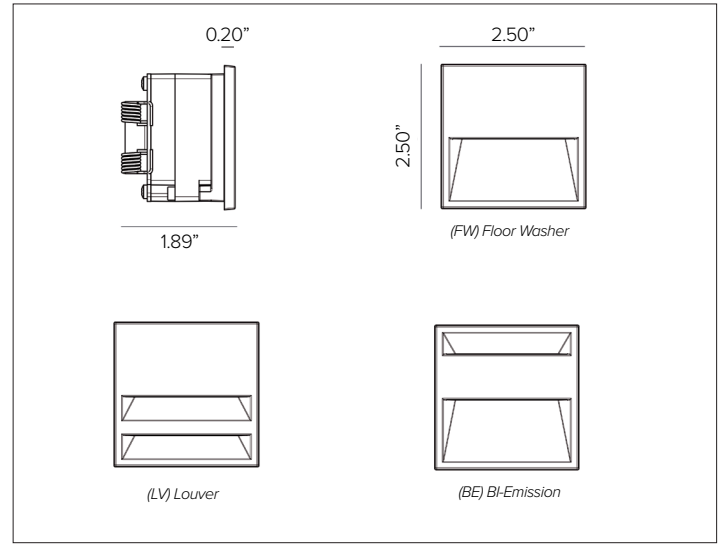

Left to right, shown in Louver faceplate shown in Deep Black finish, Bi-Emission faceplate shown in Ferrite Dark Grey finish, Floor Washer faceplate shown in Sandstone Grey finish.



CONCEPT

Recessed LED steplight for indoor and outdoor applications.
Designed in collaboration with Gensler as Product Design Consultant.

MECHANICAL CHARACTERISTICS

Housing	2.5"W x 2.5"H x 1.89"D
Materials	Die-cast anodized aluminum body fitted with a spring fixing system. Powder coated die-cast anodized aluminum external frame. Aesthetically pleasing with no visible hardware.
Finish	Textured finish. <ul style="list-style-type: none"> ● Ferrite Dark Grey ● Heritage Brown ● Bronze ● Black ● White ● Sandstone Grey
Power Connection	Pre-cabled with 3' Belden 18ga 2 conductor direct burial cable (no conduit required).
Mounting	To be completed with installation back box. Fixture secured with stainless steel spring system for semi-flush installation only. Recommended mounting height is +18" A.F.F.
BUG	B0-U0-G0 / B0-U1-G0 BE Emission only
Weight	0.35lbs
Protection	IP66
Impact	IK10

CERTIFICATIONS

cULcs Class 2 Wet Location Listed E479873.
Tested in accordance with LM-79-08.
Compliant for California installations.
RoHS3 EU 215/863

WARRANTY

5 year limited warranty

SUSTAINABILITY

Luminaire designed for disposal/recycling at end-of-life. Replaceable LED light source and control gear by a Targetti technician.

ELECTRICAL CHARACTERISTICS

Power Supply	Remote Class 2, 120V-277VAC power supply required, see available options.
Wattage	4W
Voltage	24V DC
Operating Temp.	-25°C / +35°C

SOURCE

High Efficiency LED Board. CRI dependent on version.

TM30	CCT (Nominal)	CRI	Rf	Rg	SDCM
ZEDGE MINI version	2700K	80	83	97.3	2
	3000K	80	82.9	97	2
	3500K	80	83.6	96.5	2
	4000K	80	82.6	95.7	2
	Ra90 available upon request				
ZEDGE MINI HO version	2700K	90	90.9	100.1	2
	3000K	90	90.3	100.4	2
	3500K	90	83.6	96.5	2
	4000K	90	89.8	98.7	2

OPTIC

Optical system is dependent version. FW / LV / BE versions are comprised of polycarbonate opal lens. HOFW version is comprised of polycarbonate clear lens. LV version comprised of a high reflectance anodized aluminum reflector.

Beam		FW 56°X94°	LV 49°X103°	BE 48°X79°	HO FW 27°X63°
Delivered Lumens	2700K	82Lm	37Lm	111Lm	171Lm
	3000K	87Lm	39Lm	117Lm	181Lm
	3500K	90Lm	40Lm	120Lm	186Lm
	4000K	90Lm	40Lm	121Lm	187Lm
Efficacy	48Lm/W max. Refer to photometric graphs for specific values.				
Lifetime	L80/B10 56,000hrs at max TA +25°C				
Photobiological Classification	Low risk photobiological safety RG1				

ZEDGE MINI

SPECIFICATION INFORMATION

ZES		RP		FW		FE		L1		27		24		MG		DMLE91242UD	
1		2		3		4		5		6		7		8		9 10	
														OPTIONAL		REQUIRED	

Ex: ZESRPFWFEL13024 / DELV30124D / 1US3166-B

1 - PRODUCT CODE	2 - DRIVER	3 - FACEPLATE	4 - FINISH	5 - WATTAGE	6 - KELVIN	7 - VOLTAGE
ZES — ZEDGE MINI	RP — Remote Power	FW — Floor Washer	FE — Ferrite Dark Grey	L1 — 4W	27 — 2700K	24 — 24V DC
ZESHO ^B — ZEDGE MINI HIGH OUTPUT		LV — Louver	HB — Heritage Brown	L2 — 4W	30 — 3000K	
		BE — Bi-Emission	BZ — Bronze			35 — 3500K
		FW — Floor Washer	WT — White		40 — 4000K	
			BT — Black			
			SG — Sandstone Grey			
			RAL — Custom RAL			

8 - OPTIONAL	9 - POWER SUPPLY	10 - INSTALLATION
MG ^A — Marine Grade	Power Supply <i>See section for details</i>	PVC Back Box <i>See section for details</i>
		Stainless Steel Back Box <i>See section for details</i>
		Mud Kit <i>See section for details</i>

^AMarine Grade is recommended for use in environments with occasional exposure to salt air, reclaimed water, fertilizers, chemical cleaners, or frequent pressure washing (steam) cleaning. Fixture housing complete with marine grade cataphoresis suitable for use in marine grade environments. Not to be in direct contact with salt or corrosive agents for extended periods of time.

^BHigh Output version only available in FW faceplate and L2 wattage.

For applicable quick ship items, see model configurations listed below. Lead time for quick ship fixtures is 1-2 weeks from processed PO date. Consult factory for quantities of over 20pcs to confirm lead time.

 QSZESRPFWFEL13024 + 1US3166 + DMLE301242UD / DMLE601242UD / DMLE961242UD
 QSZESRPFWBTL13024 + 1US3166 + DMLE301242UD / DMLE601242UD / DMLE961242UD

FACEPLATE VERSIONS

(FW) FLOOR WASHER

Uniform optical distribution on the floor and excellent visual comfort.

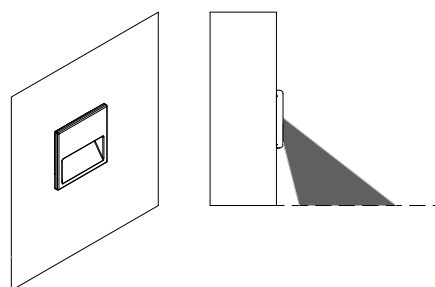

(LV) LOUVER

High visual comfort with source entirely hidden from view through two openings.

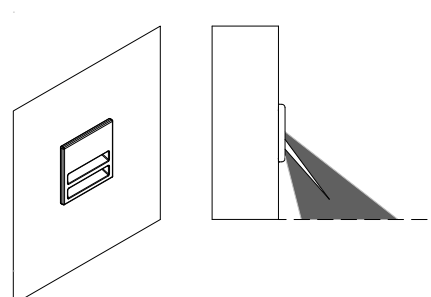

(BE) BI-EMISSION

The floor washer optic combined with indirect illumination.

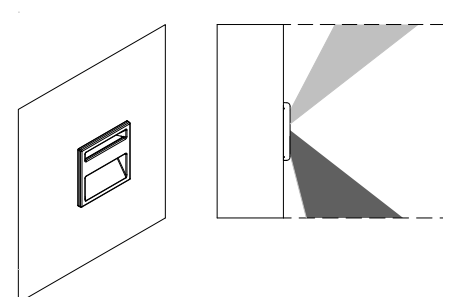

ZEDGE MINI

9 - POWER SUPPLY (REQUIRED)

ENCLOSURE								
Part No.	Wattage	Control	Dim Range	Rating	In / Out Voltage	Certification	Dimensions (Enclosure)	Description
DMLE301242UD	30W	MLV / ELV / 0-10V / TRIAC	MLV <10% / ELV <10% / 0-10V <5%	NEMA3R	120-277V / 24V	UL Class 2	4.47" X 6.79" X 1.38"	EMCOD MLE-UD electronic driver with wiring compartment.
DMLE601242UD	60W	MLV / ELV / 0-10V / TRIAC	MLV <10% / ELV <10% / 0-10V <5%	NEMA3R	120-277V / 24V	UL Class 2	4.47" X 6.79" X 1.38"	EMCOD MLE-UD electronic driver with wiring compartment.
DMLE961242UD	96W	MLV / ELV / 0-10V / TRIAC	MLV <10% / ELV <10% / 0-10V <5%	NEMA3R	120-277V / 24V	UL Class 2	5.16" X 7.73" X 1.54"	EMCOD MLE-UD electronic driver with wiring compartment.
DEDDX100241CDMX	100W	DMX 1Ch Group Control	0%	NEMA3R	120-277V / 24V	UR Class 2	12" x 12" x 4"	EldoLED LINEARdrive electronic driver.
DMLE1922242UD	2X96W	MLV / ELV / 0-10V / TRIAC	MLV <10% / ELV <10% / 0-10V <5%	NEMA3R	120-277V / 24V	UL Class 2	5.04" X 10.94" X 1.81"	EMCOD MLE-UD electronic driver with wiring compartment.
DMLE2882242UD	3X96W	MLV / ELV / 0-10V / TRIAC	MLV <10% / ELV <10% / 0-10V <5%	NEMA3R	120-277V / 24V	UL Class 2	5.04" X 10.94" X 1.81"	Magnitude SOLIDrive electronic driver with built in junction box.
DEDDX200241CDMX	2X100W	DMX 1Ch Group Control	0%	NEMA3R	120-277V / 24V	UL Class 2	12" x 12" x 4"	EldoLED LINEARdrive electronic driver.

MAX FIXTURES PER DRIVER								
Fixture Wattage	Driver Wattage							
	30W	60W	96W	100W	2X96W	3X96W	3X100W	
	4W	6	12	19	20	19+19	19+19+19	20+20+20

ZEDGE MINI

10 – INSTALLATION (REQUIRED)

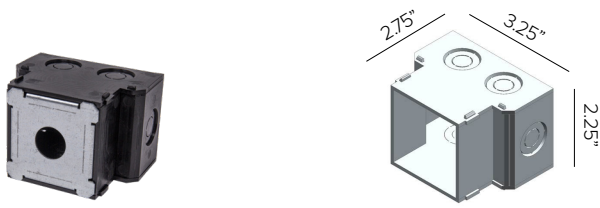

ZEDGE MINI PVC installation back box for semi-flush installations fitted for parallel connection with feed through-wiring, black finish. 6ea knockouts for 1/2" conduit made for low voltage cable (no conduit required, Class 2 wiring). **For use in drywall or stucco applications.**

Part No. **1US3166-B**

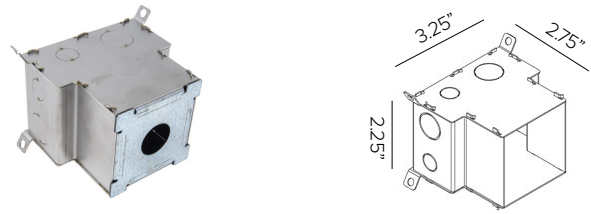

ZEDGE MINI stainless steel installation back box for semi-flush installations fitted for parallel feed through-wiring connection. 2ea 3/8" and 2ea 1/2" grommets provided for low voltage cable (no conduit required, Class 2 wiring). **For use in concrete pour outdoor/harsh environment applications.**

Part No. **1US3166**

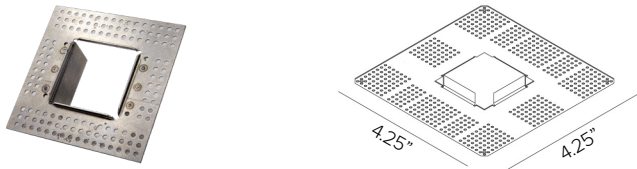

ZEDGE MINI mud plate. **For use in retrofit Class 2 installations in drywall or stucco applications.**

Part No. **1USMK01**

ZEDGE MINI

WIRING DIAGRAM

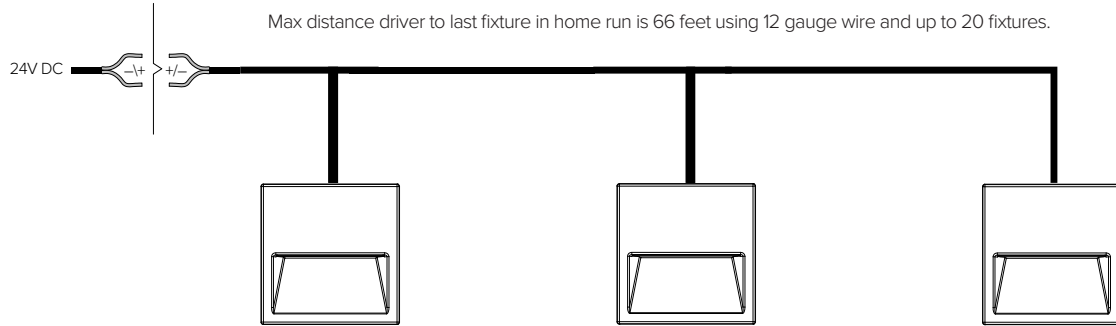

MAXIMUM CABLE DISTANCE

No. Fixtures	Load	18 AWG	16 AWG	14 AWG	12 AWG
1-4	≤16W	72ft	115ft	180ft	290ft
5-8	≤32W	42ft	67ft	106ft	165ft
9-12	≤48W	28ft	44ft	70ft	112ft
13-16	≤54W	20ft	33ft	52ft	84ft
17-20	≤80W	16ft	26ft	41ft	66ft

**Voltage drop calculations are based on 3% max drop to last fixture in run for load and distances below*

SUGGESTED MOUNTING DIAGRAM

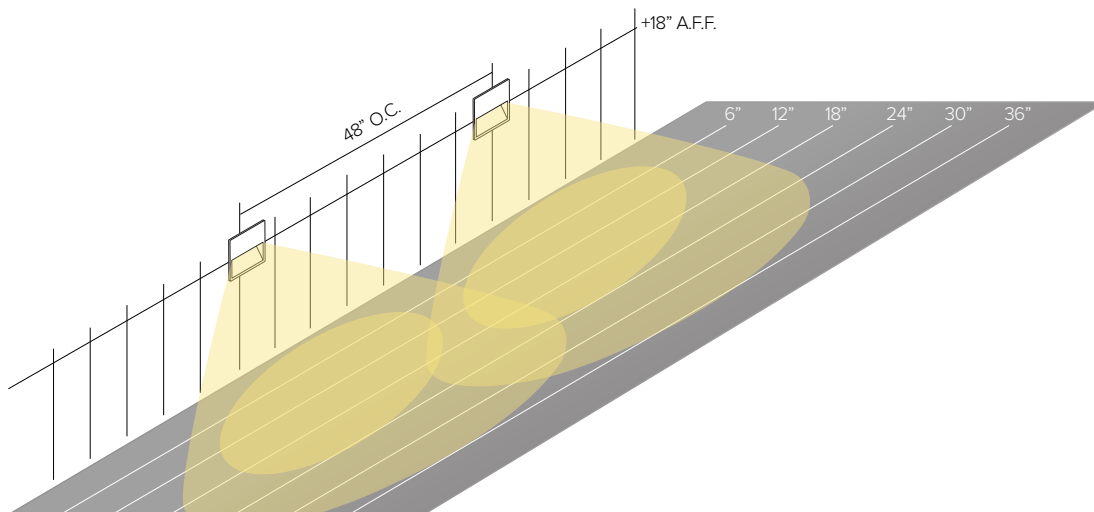

Recommended mounting height is +18" A.F.F. on 48" center spacing to meet egress requirements of ffc minimum.

**Fixture calculated Floor Wash Faceplate using 3000K and White finish.*

ZEDGE MINI

PHOTOMETRY

ZEDGE MINI – FLOOR WASHER

	2700K	H(m)	D1(m)	D2(m)	E _{max} (lx)		
	Ra80		56°	94°			
	Fixture Power	4W	1	2.59	2.40	44	
	Source Flux	608lm	2	5.19	4.79	11	
	Fixture Flux	78lm	3	7.78	7.19	5	
	Efficacy	20lm/W	4	10.37	9.59	3	
TS999	I _{max} =90cd/klm	I _{max}	55cd	5	12.97	11.98	2

	3000K	H(m)	D1(m)	D2(m)	E _{max} (lx)		
	Ra80		56°	94°			
	Fixture Power	4W	1	2.59	2.40	47	
	Source Flux	645lm	2	5.19	4.79	12	
	Fixture Flux	83lm	3	7.78	7.19	5	
	Efficacy	21lm/W	4	10.37	9.59	3	
TS999	I _{max} =90cd/klm	I _{max}	58cd	5	12.96	11.99	2

	3500K	H(m)	D1(m)	D2(m)	E _{max} (lx)		
	Ra80		56°	94°			
	Fixture Power	4W	1	2.59	2.40	48	
	Source Flux	662lm	2	5.19	4.79	12	
	Fixture Flux	85lm	3	7.78	7.19	5	
	Efficacy	22lm/W	4	10.37	9.59	3	
TS999	I _{max} =90cd/klm	I _{max}	60cd	5	12.97	11.99	2

	4000K	H(m)	D1(m)	D2(m)	E _{max} (lx)		
	Ra80		56°	94°			
	Fixture Power	4W	1	2.59	2.40	48	
	Source Flux	666lm	2	5.19	4.79	12	
	Fixture Flux	86lm	3	7.78	7.19	5	
	Efficacy	22lm/W	4	10.37	9.59	3	
TS999	I _{max} =90cd/klm	I _{max}	60cd	5	12.96	11.98	2

ISOLUX DIAGRAM

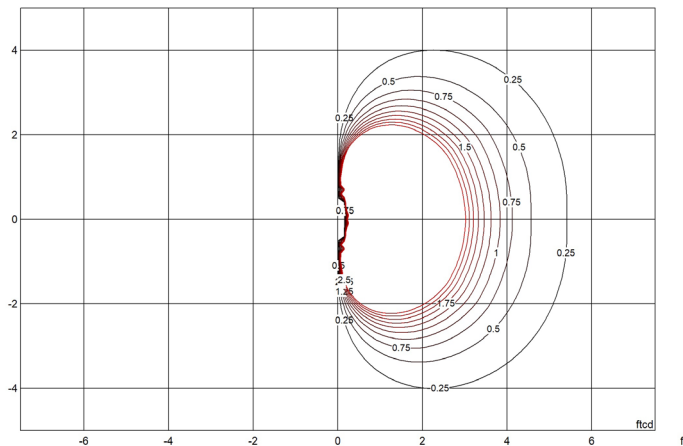

MOUNTING HEIGHT = 18"

LCS GRAPH

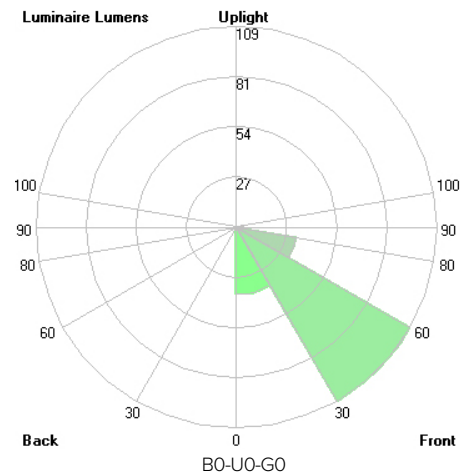

ZEDGE MINI

PHOTOMETRY

ZEDGE MINI – LOUVER

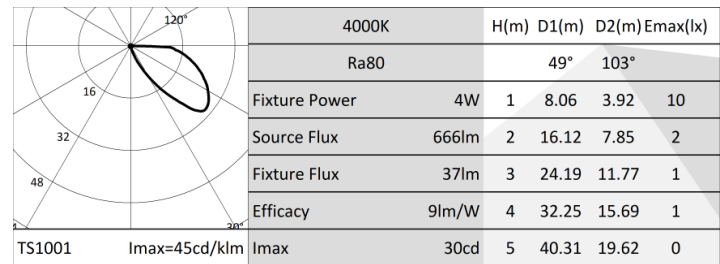
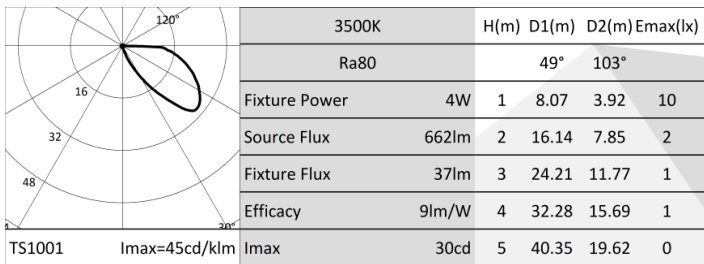
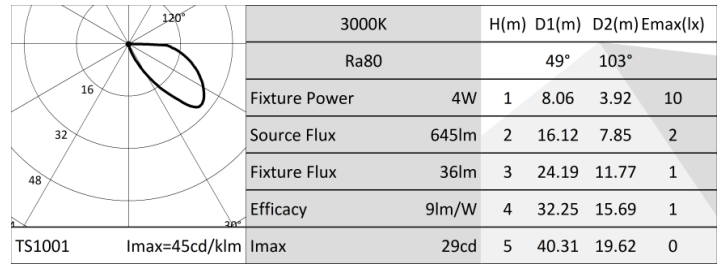
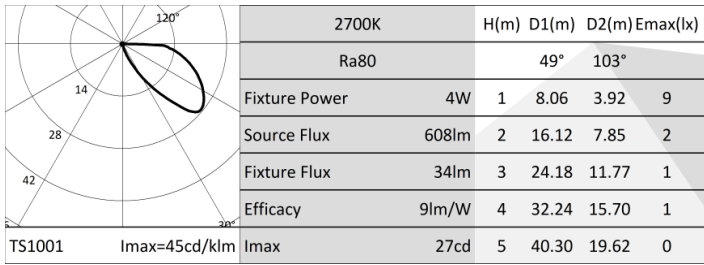

ISOLUX DIAGRAM

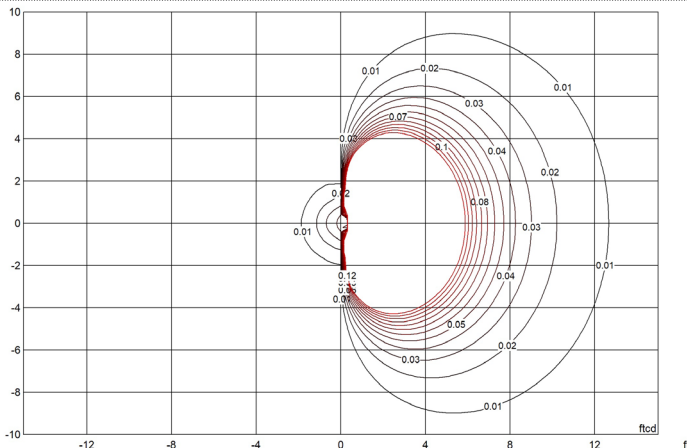

MOUNTING HEIGHT = 18"

LCS GRAPH

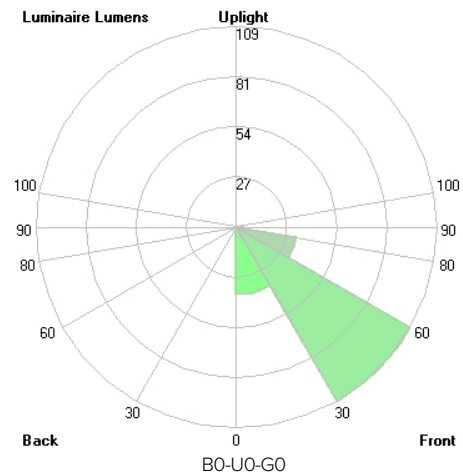

ZEDGE MINI

PHOTOMETRY

ZEDGE MINI – BI-EMISSION

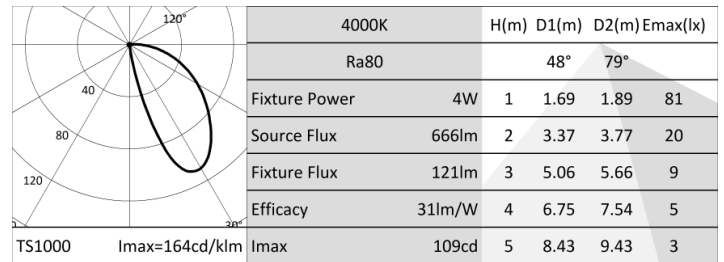
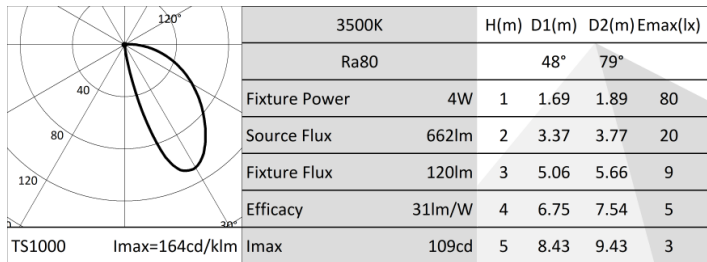
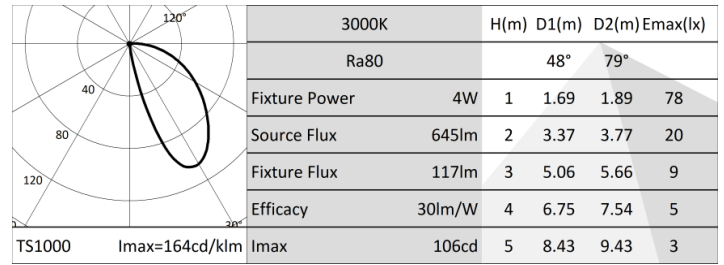
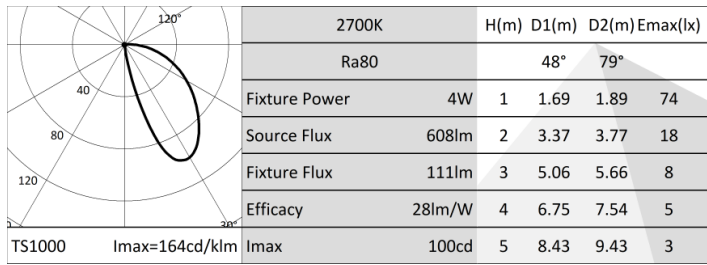

ISOLUX DIAGRAM

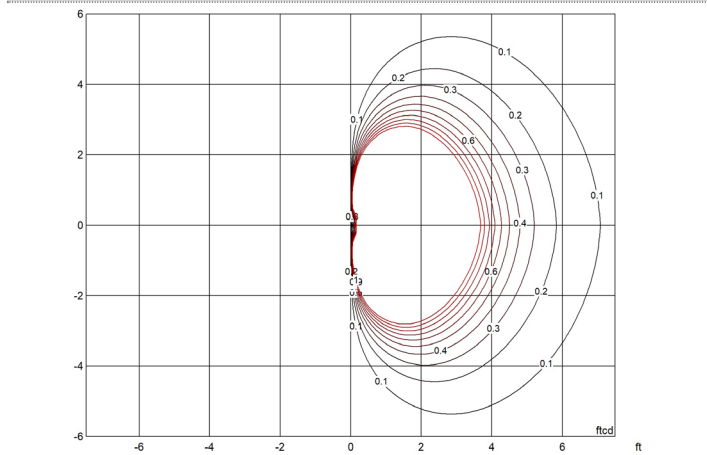

LCS GRAPH

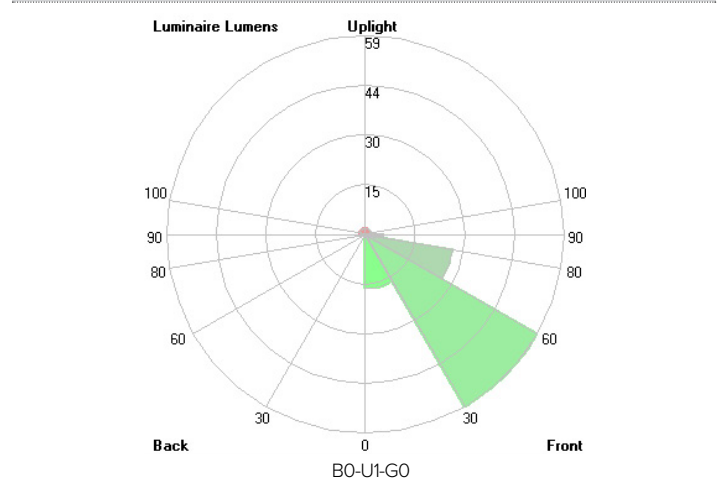

ZEDGE MINI

PHOTOMETRY

ZEDGE MINI HO – FLOOR WASHER

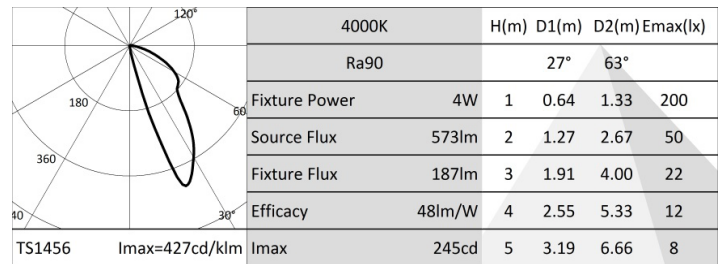
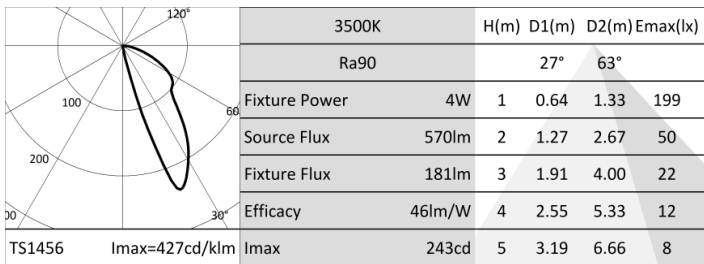
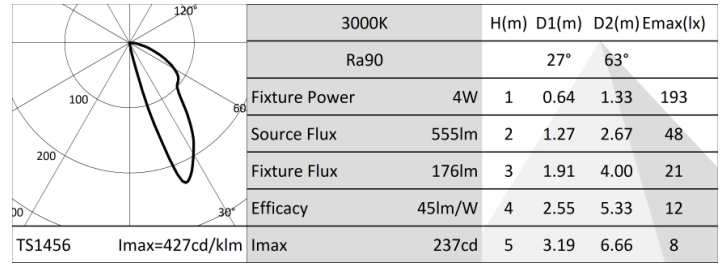
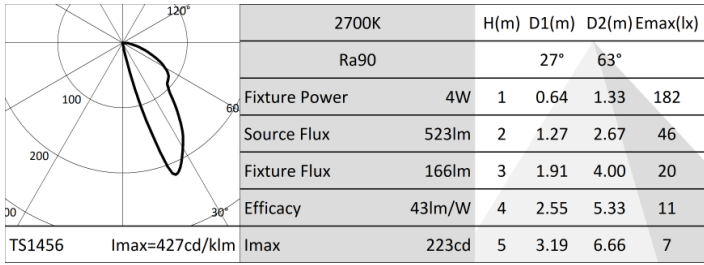

ISOLUX DIAGRAM

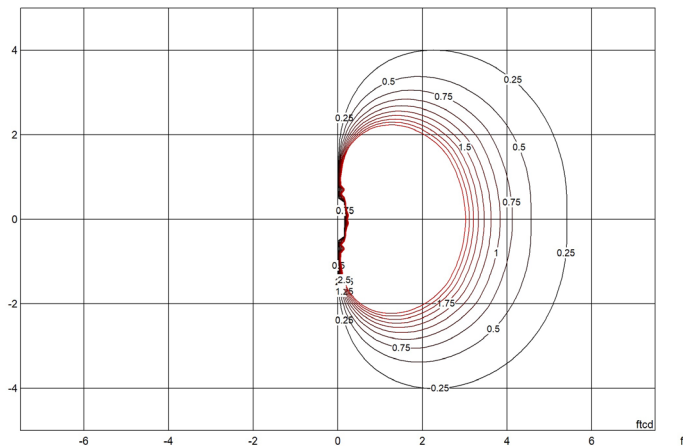

MOUNTING HEIGHT = 18"

LCS GRAPH

