

# V15R-P

1.5" O.D. V-Rail Spot - Point Source

<b>JOB NAME</b>		<b>CATALOG NUMBER</b>	
<b>NOTES</b>		<b>TYPE</b>	

## ELECTRICAL DATA (PER ENGINE)

Distribution	Nominal Delivered Lumens (Per Engine)	System Wattage	Efficiency
Wide Flood Symmetric Asymmetrical	<b>L1:</b> 150lm @ 3000K / 80CRI <b>L1:</b> 148lm @ 3000K / 80CRI	1.9W (Per Engine)	79 lm/W 78 lm/W
Wide Flood Symmetric Asymmetrical	<b>L2:</b> 211lm @ 3000K / 80CRI <b>L2:</b> 208lm @ 3000K / 80CRI	2.7W (Per Engine)	78 lm/W 77 lm/W

### SERVICE

- Intense Lighting provides shop drawings/specifications to satisfy architects and electrical contractors when an order is placed
- Railing is fabricated to site specifications included in your order
- All light engines are assembled at the factory and shipped integral to the rail for ease of installation

### CONSTRUCTION AND FINISH

- Internal Construction: Heavy duty Anodized 6082-T6 Aluminum Alloy
- External Rail Jacket: Available in 304 or 316 Stainless steel
- Standard finishes include #4 satin brushed stainless steel or powder coated silver, white, black, or bronze (AAMA 2604) Consult factory for custom material, custom polish finish, or custom powder coated finishes

### DIMMING

- 0-10V 10%; Universal 120V-277V
- Lutron LTEA2W Hi-Lume 2-Wire 1%; 120V only

### LED LIGHT SOURCE

- High power chip scale package for high efficacy performance and energy conservation in a compact form factor
- 80 CRI 2700K, 3000K, 3500K or 4000K
- 3 Step MacAdam (3 SDCM)
- Rated life of >50,000 hours L70 based on LED testing per LM-80-08 and projected values using IESNA TM21-11
- Light engines are easily accessible for field maintenance

### OPTICAL SYSTEM

- Patent pending fully integrated optical system and light shaping diffuser for up to 80% transmission efficiency with precise shaping, control and distribution of light
- High-impact acrylic lens is secured with (2) fasteners with recessed accessibility for tamper resistance. Dedicated optic distributions include asymmetric and wide flood symmetric

### REMOTE MOUNTING POWER SUPPLY

- Configured per project requirements.
- Supplies 24V electronically stabilized power to LED's. U.L. Class 2 output for safe operation.
- Housed to NEMA rated enclosures (optional)

### INTEGRAL POWER SUPPLY

Supplies 24V electronically stabilized power to LED's. U.L. Class 2 output for safe operation. Surface Mounted Post or embedded mounted Post are available. See mounting submittal sheets for detailed information.

### MOUNTING / INSTALLATION

Wall, post, or embedded mount is available. See mounting submittal sheets for detailed information.

### EMERGENCY

Remote emergency inverter available. Can be remote up to 1000 ft.

### WARRANTY / LISTINGS

- 5-year Limited Warranty (LED & Power Supply Only)
- ETL Wet Location Listed
- IDA Approved
- ADA Compliant
- PATENT# 11,333,310 B2

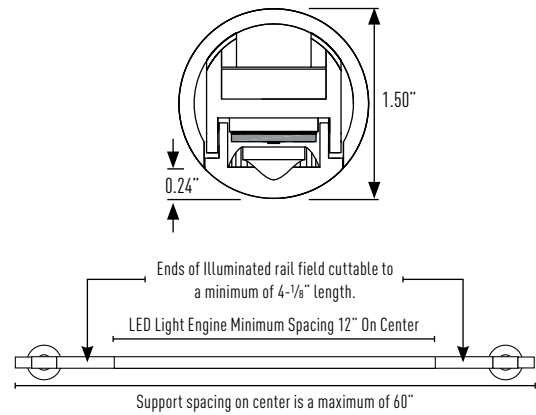

**V-Rail (Example: V15R-P12-ST4S4-P36M-L127WF-RD10UNV-EM3)**  
(Specify Quantity By Foot)

Series	Spacing On Center	Material	Finish	Mounting	Style	Output (Per Engine)	CCT/CRI
<b>V15R-P</b>	<b>12</b> (12" Spacing)	<b>-ST4</b> (304 Stainless Steel)	<b>S4</b> (Satin #4 Brushed Finish)	<b>-P36</b> (34-38in, Post Mount)	<b>M</b> (Modular)	<b>-L1</b> (1.9W)	<b>27</b> (2700K / 80CRI)
	<b>24</b> (24" Spacing)	<b>-ST6<sup>3</sup></b> (316 Stainless Steel)	<b>W</b> (White, Powder Coat)	<b>-P42</b> (42in, Post Mount)	<b>S</b> (Seamless)	<b>-L2</b> (2.7W)	<b>30</b> (3000K / 80CRI)
	<b>30</b> (30" Spacing)	<b>-C</b> (Custom, Consult Factory)	<b>B</b> (Black, Powder Coat)	<b>-E36</b> (34-38in, Embedded Mount)			<b>35</b> (3500K / 80CRI)
	<b>36</b> (36" Spacing)		<b>BR</b> (Bronze, Powder Coat)	<b>-E42</b> (42in, Embedded Mount)		<b>40</b> (4000K / 80CRI)	
	<b>48</b> (48" Spacing)		<b>SV</b> (Silver, Powder Coat)	<b>-WB<sup>1</sup></b> (Wall Bracket)			
	<b>60</b> (60" Spacing)		<b>C</b> (Custom, Consult Factory)	<b>-GB<sup>1</sup></b> (Glass / Guardrail Bracket)			
	<b>C</b> (Custom, Consult Factory)		<b>-C</b> (Custom, Consult Factory)				

Beam	Style	Dimming	Voltage	Options
<b>WF</b> (Wide Flood, Symmetric)	<b>-R</b> (Remote Power Supply)	<b>NON</b> (Non-Dimming)	<b>UNV</b> (Universal, 120V-277V)	<b>-I</b> (Infill, Consult Factory For Infill Options)
<b>AS</b> (Asymmetric)	<b>-I<sup>1</sup></b> (Integral Power Supply)	<b>D10<sup>8</sup></b> (0-10V 10%)	<b>120</b> (120V)	<b>-CU<sup>9</sup></b> (Curved Rail Layout, Consult Factory)
		<b>LUT2<sup>4,7,8</sup></b> (LTEA2W Lutron Hi-Lume 2-Wire 1%)	<b>277</b> (277V)	
		<b>C<sup>9</sup></b> (Custom, Consult Factory)	<b>347<sup>5,6</sup></b> (347V-480V)	

### Emergency Accessories

- EM1<sup>2</sup>** (EM Backup 125W, [IB-IIS-125-SM](#))
- EM3<sup>2</sup>** (EM Backup 375W, [IB-IIS-375-LED](#))
- EM5<sup>2</sup>** (EM Backup 550W, [IB-IIS-550-I](#))
- EM5HE** (High Efficiency EM Backup 550WHE, [IB-IIS-550-HE](#))

### Notes:

- Not compatible with integral driver option
- Compatible with 120V or 277V only
- Longer lead time may apply
- 120V Only
- Available in non-dimming only
- Remote Only
- Integral Only
- Consult Factory
- Must select Voltage; 120V or 277V

V-RAIL LUM-111522 P-1

INTENSE LIGHTING | 3340 E La Palma Ave, Anaheim, CA 92806 | tel 714 630-9877 | fax 714 630-9883

For Intense Lighting's limited product warranty, go to [www.intenselighting.com](http://www.intenselighting.com). For a printed copy of the warranty, you may call 800 961-5321.

© 2022 Intense Lighting, LLC. All rights reserved. Note: This document is subject to change without notice.

# V15R-P

1.5" O.D. V-Rail Spot - Point Source

JOB NAME		CATALOG NUMBER	
NOTES		TYPE	

## Symmetrical Distribution (Per Engine)

(L2: 2.7W at 3000K / 80 CRI)

PHOTOMETRIC CURVE:

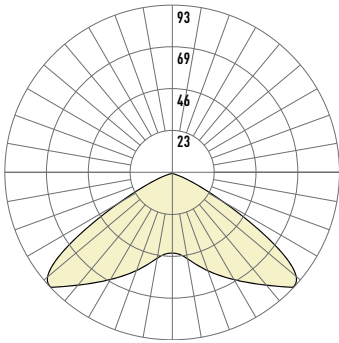

Lumens: 211 lm  
Efficacy: 78 lm/W

Wattage: 2.7W  
CCT: 3000K / 80CRI

(5ft on Center / 36" Rail / 20ft Run)

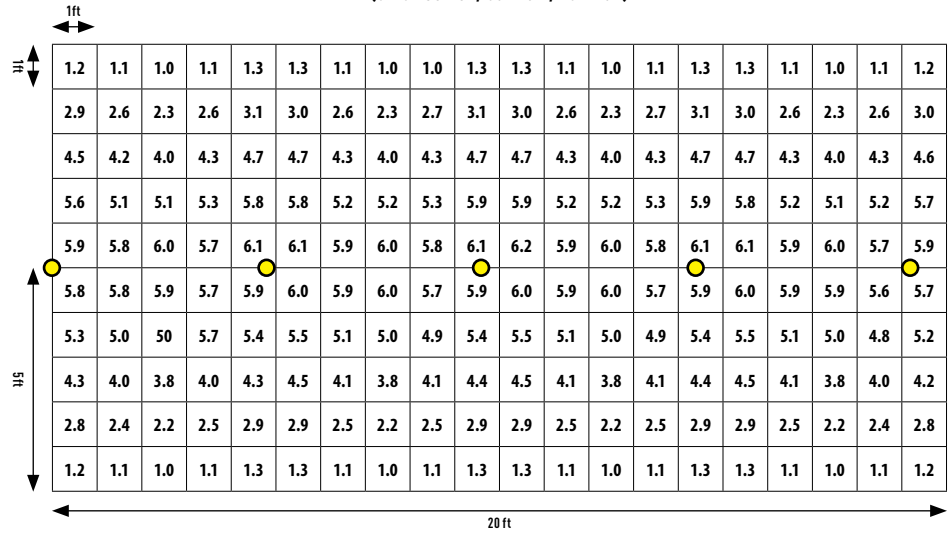

(2ft on Center / 36" Rail / 20ft Run)

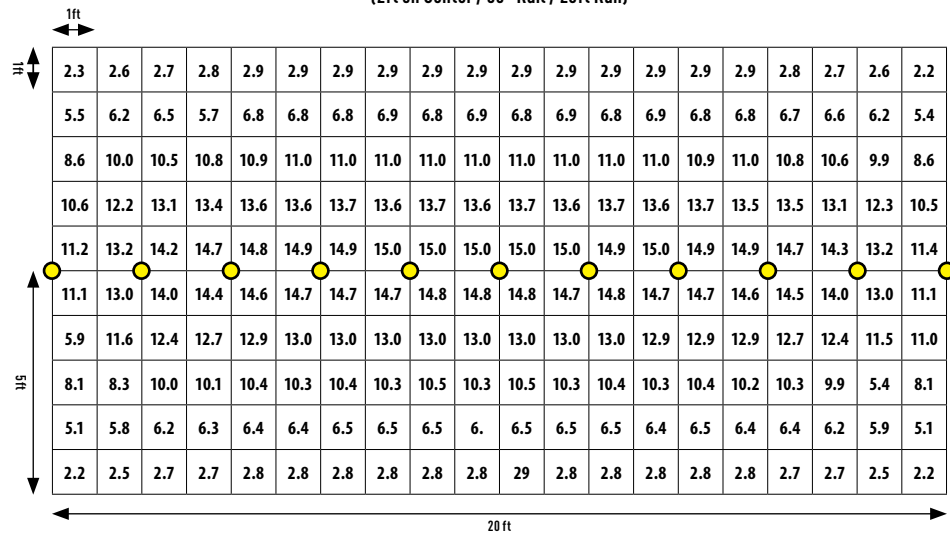

# V15R-P

1.5" O.D. V-Rail Spot - Point Source

JOB NAME		CATALOG NUMBER	
NOTES		TYPE	

## Asymmetrical Distribution (Per Engine) (L2: 2.7W at 3000K / 80 CRI)

PHOTOMETRIC CURVE:

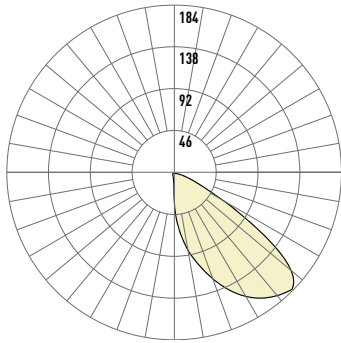

Lumens: 208 lm  
Efficacy: 77 lm/W

Wattage: 2.7W  
CCT: 3000K / 80CRI

(5ft on Center / 36" Rail / 20ft Run)

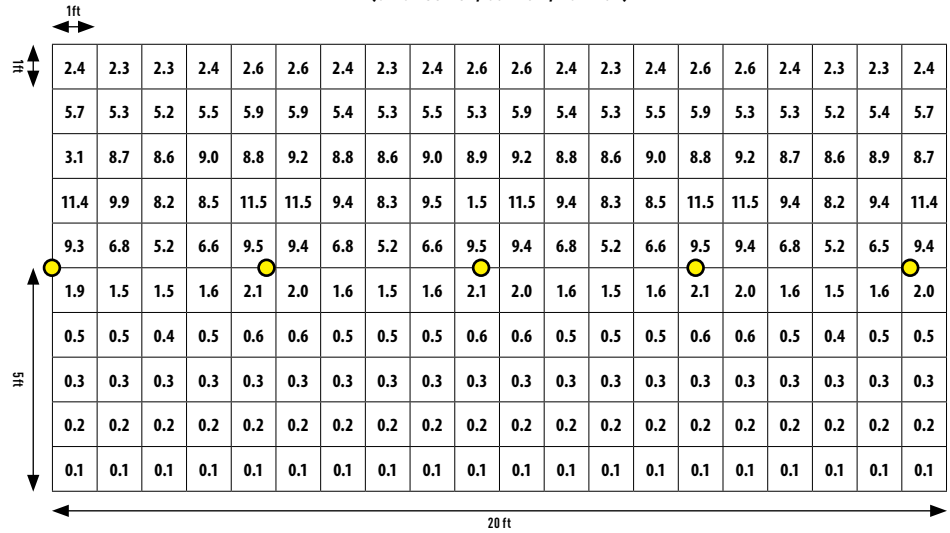

(2ft on Center / 36" Rail / 20ft Run)

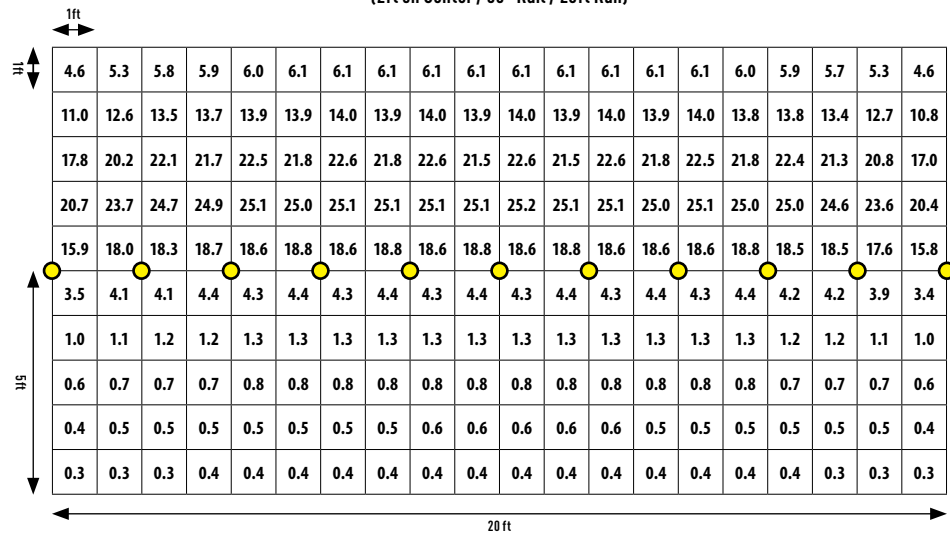

# V15R-P

1.5" O.D. Remote Post Embedded Assembly

<b>JOB NAME</b>		<b>CATALOG NUMBER</b>	
<b>NOTES</b>		<b>TYPE</b>	

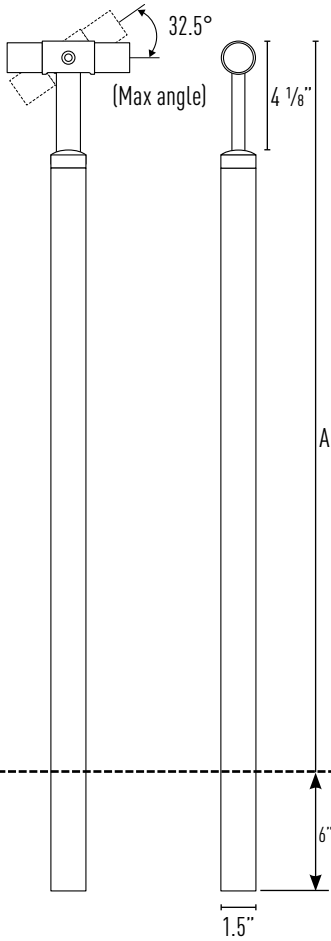

DIMENSIONS	
	Handrail
<b>A</b>	42" - 38"

## CONSTRUCTION AND FINISH

Embedded mount assembly is available in 304 or 316 No.4 polished stainless steel. Periodic cleaning is required to preserve stainless finish. 316 Stainless Steel is recommended for installations in coastal areas, near bodies of water, or other harsh environments. Available finishes include #4 satin or powder coated silver, white, black and bronze (AAMA 2604). Consult factory for custom material, custom polish finish, or custom powder coated finishes.

## MOUNTING / INSTALLATION

Post are to be spaced at a maximum of 60" on centers. Embedded mount post are set into place using Rockite® or Kwixset® anchor cement. A minimum of 6" post must be embedded into concrete to structurally secure post. Anchoring means and size must be determined by local codes. Not to be supplied or engineered by Intense Lighting. See Embedded Mount Installation detail for more information.

## FITTINGS

Consult factory for standard fittings and epoxy weld adhesive.

## INFILL OPTIONS

V-Rail is compatible with multiple infill options. Infill can be supplied by Intense Lighting or others. Custom infills supplied by Intense Lighting may require a structural analysis, please contact factory. Post apacing maximum may vary depending on infill chosen.

## INFILL OPTIONS



## Embedment Installation Detail

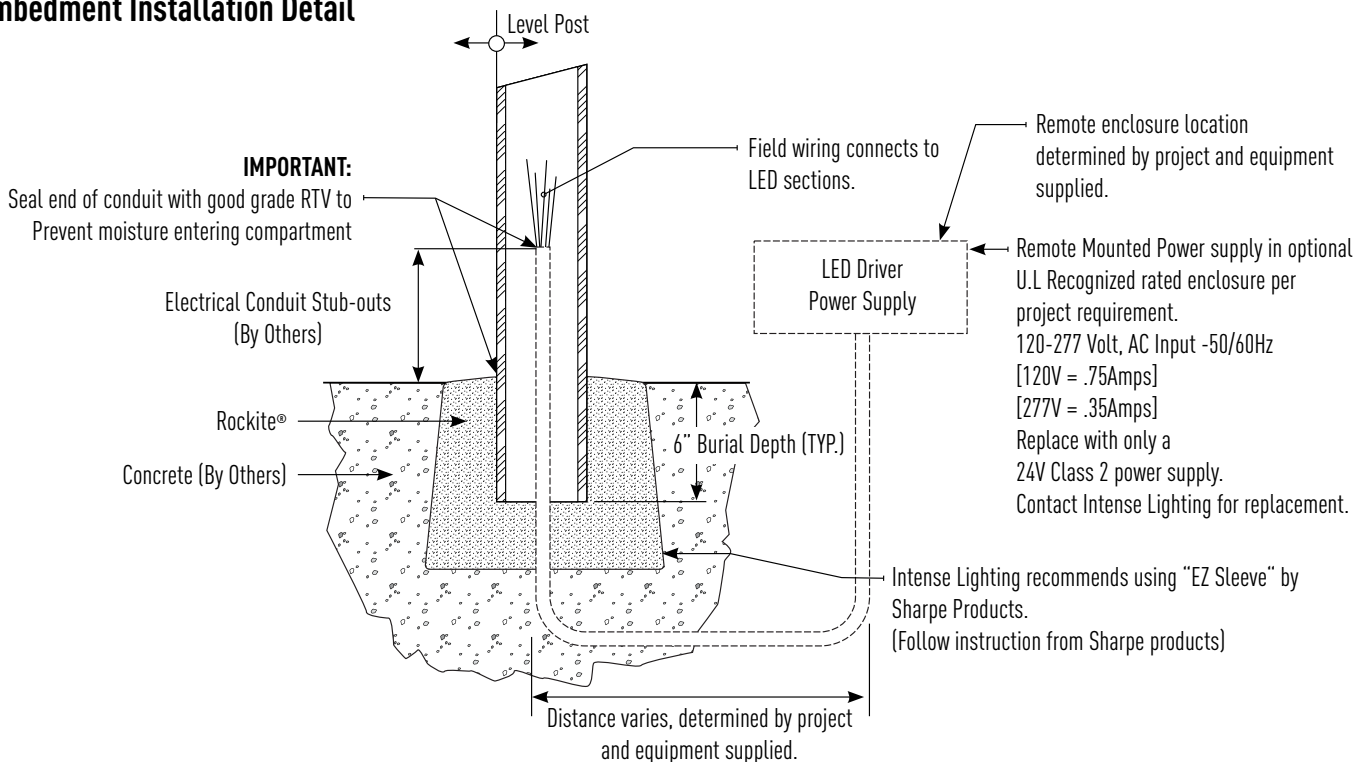

# V15R-P

## 1.5" O.D. Remote Wall Mount Assembly

<b>JOB NAME</b>		<b>CATALOG NUMBER</b>	
<b>NOTES</b>		<b>TYPE</b>	

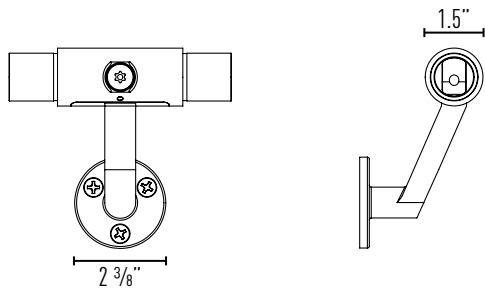

### CONSTRUCTION AND FINISH

Wall mount assembly is available in No.4 polished 304 stainless steel. Periodic cleaning is required to preserve stainless finish. 316 Stainless Steel is recommended for installations in coastal areas, near bodies of water, or other harsh environments. Available finishes include #4 satin or powder coated silver, white, black and bronze (AAMA 2604). Consult factory for custom material, custom polish finish, or custom powder coated finishes.

### MOUNTING / INSTALLATION

Supports are to be spaced at a maximum of 60" on centers. Wall mount assembly is to be mounted to concrete wall utilizing anchor bolts (supplied by others). Anchoring means and size must be determined by local codes. Not to be supplied or engineered by Intense Lighting. See Wall Mount Installation detail for more information. Anchorage template available by request.

### FITTINGS

Consult factory for standard fittings and epoxy weld adhesive.

### WALL BRACKET SPECIFICATION

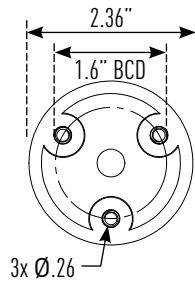

## Wall Mounted Installation Detail

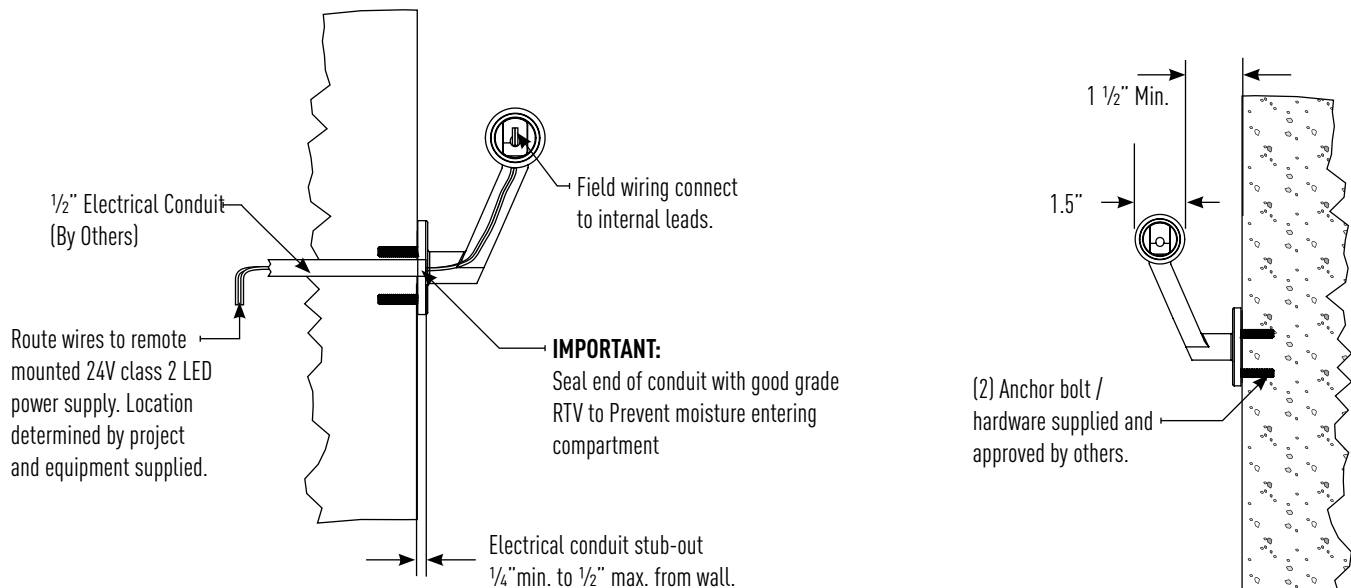

# V15R-P

Remote Power Supply - Multiple Output Wet Location Enclosure

JOB NAME	CATALOG NUMBER	TYPE
NOTES		

## Nema 4x UL Listed Outdoor Rated PVC Boxes

Non-Corroding, Non-Conducting, Fire Resistant, Concrete Tight



Suitable for Surface Mount and Recessed Mount

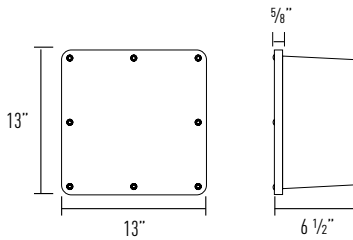

### LED Remote Power Supply "No Dimming"

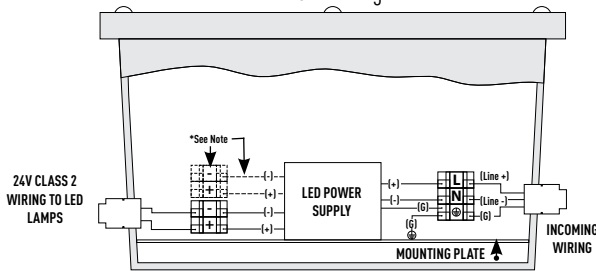

### LED Remote Power Supply "With Dimming"

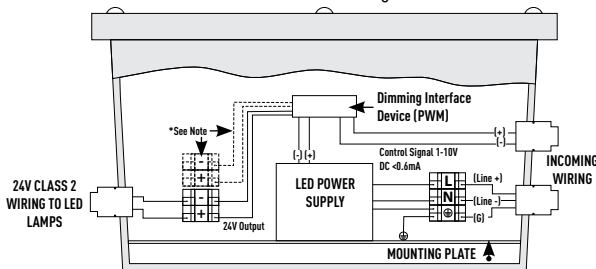

Wire gauge to be determined per project. Voltage drop occurs with distance. Any change in wire length requires re-engineering.

\*Notes: Dash lines represent additional outputs when supplied per project.

All components inside enclosure are supplied by Intense Lighting.

External connections and means to be determined by the local authority having jurisdiction. Not to be engineered or supplied by Intense Lighting.

**IVR-RPS-1-0T96** - (1) 96W 120/277V (1) 24V Outputs

**IVR-RPS-2-0T96** - (2) 96W 120/277V (2) 24V Outputs

#### FEATURES

- Protected against open circuit, short circuit, overload and overheating issues
- Universal 120-277V input
- Suitable for damp and wet locations
- Easy connectivity to terminal blocks
- Integrated 0-10V dimming available

#### SPECIFICATIONS

- Input Power: 108-305VAC, 50/60 Hz, .91A @ 120VAC
- Output Power: 96W 24V DC
- Ambient Temperature Range: -22°F to 158°F (-30°C to 70°C)<sup>1</sup>
- Classification: Class 2
- Protection Rating: IP66

#### NOTES:

1.IB-0T96 Only

**IVR-RPS-1-ADV24V-347** - (1) 96W 347V (1) 24V Outputs

**IVR-RPS-2-ADV24V-347** - (2) 96W 347V (2) 24V Outputs

#### FEATURES

- Protected against open circuit, short circuit, overload and overheating issues
- Ideal for projects in USA with 480V input
- Ideal for projects in Canada with 347V input

#### SPECIFICATIONS

- Input Power: 347-480VAC,
- Output Power: 100W 24V DC
- Ambient Temperature Range: -40°C to 65°C
- Classification: Class 2
- Protection Rating: IP66

# V15R-P

1.5" O.D. V-Rail Spot - Point Source

JOB NAME		CATALOG NUMBER	
NOTES		TYPE	

## Specification and Delivery Process

Architectural drawings or detailed elevation drawings are required for a V-Rail quotation. A photometric layout will be provided if requested. Once an order is placed, Intense Lighting will provide detailed shop drawings for approval.

V-Rail will be delivered to the job site ready for installation. A detailed assembly drawing will be provided along with dimensions for remote power supplies. All products included will be labeled clearly to match the assembly drawing. Certain tools and equipment will be required for the assembly of V-Rail. A detailed list of tools can be found in the V-Rail Installation Guide. Installation guide available upon request, consult factory.

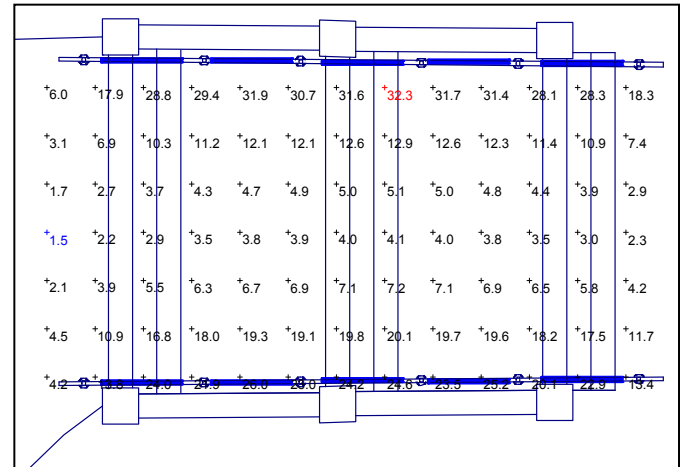

Photometric Layout

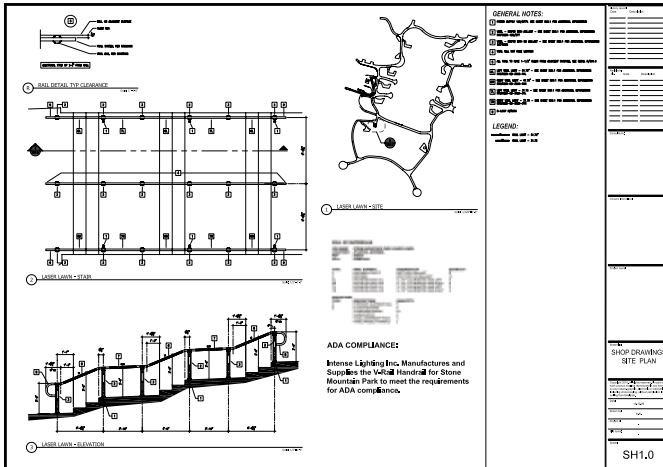

Shop Drawing / Assembly Guide



Completed Project