

# AWNING DETAILS

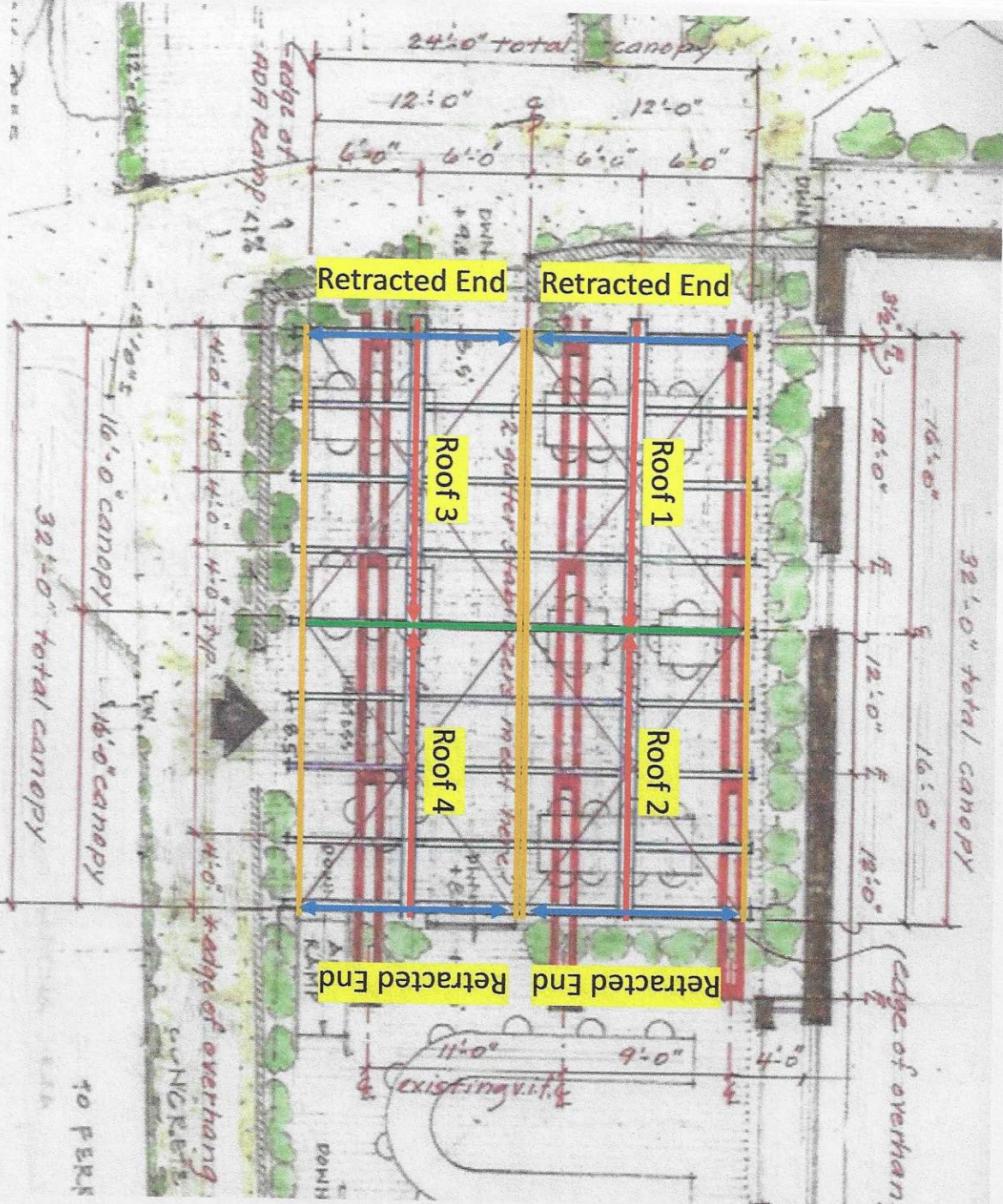

**Legend:**

- Drive Beams
- ↔ Water flow
- Gutters
- Rain Hoods

**(4) SFX Retractable Roof**

- Roof 1 = 16x12
- Roof 2 = 16x12
- Roof 3 = 16x12
- Roof 4 = 16x12

**Notes:**

- Water to drain out which end & How?
- (A) Open Slot
- (B) Gutter Spout

Item # 878402

Serge Ferrari Solits® Prof 502  
(Précontraint® Satin) Awning  
70.9" Terracotta 502V2-20185C

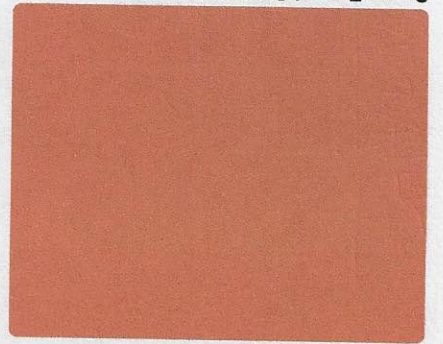

Recently Viewed Products

		43		
		Standard Package:		

By using this website, you agree to our use of cookies. To learn more, please view our [privacy policy](#).

OK

Privacy - Terms

^

## MOUNTING OPTIONS

Standard

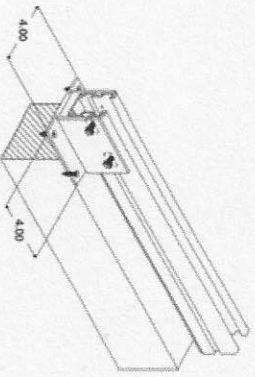

Parallel to Rafters

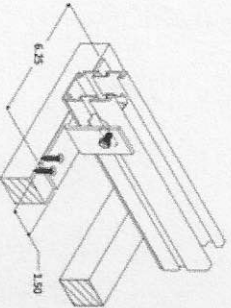

Perpendicular to Rafters

## STABILIZATION OPTIONS

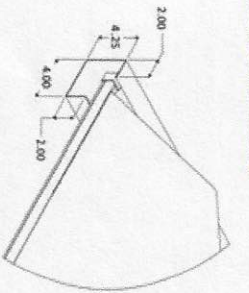

G-Channel Stabilizer

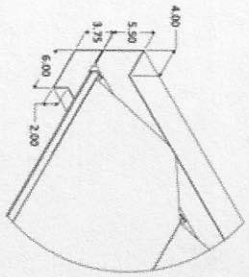

Gutter Stabilizer

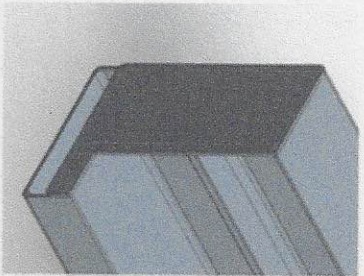

## Standard Gutter Cap 1" Slot

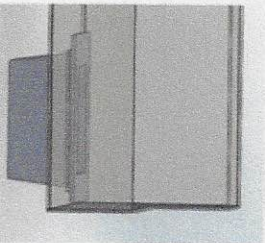

Example Gutter Spout

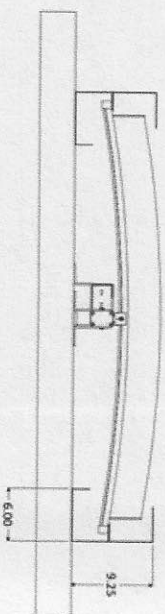
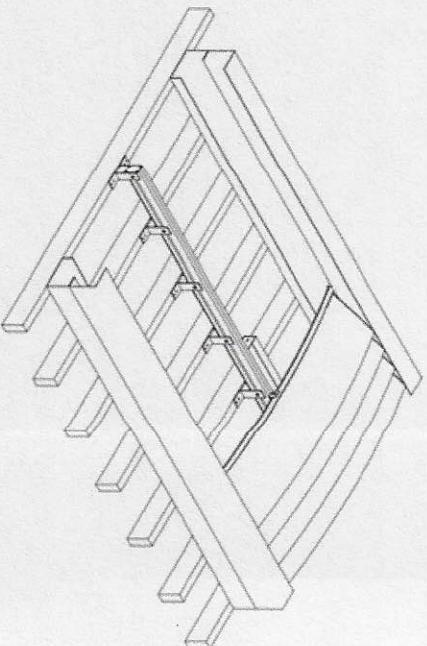

Rain Hoods

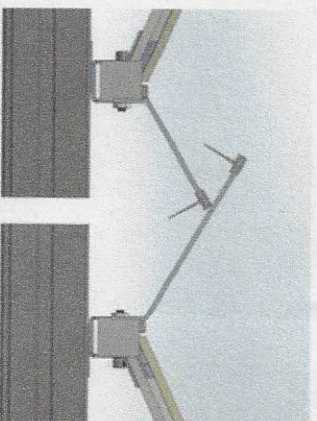

Sebastian Fox  
Product Specialist

[sebastian.fox@fox.com](mailto:sebastian.fox@fox.com) | 855.509.5509 x 215



# MOTOR OPERATED RETRACTABLE ROOF SYSTEM

## Side View

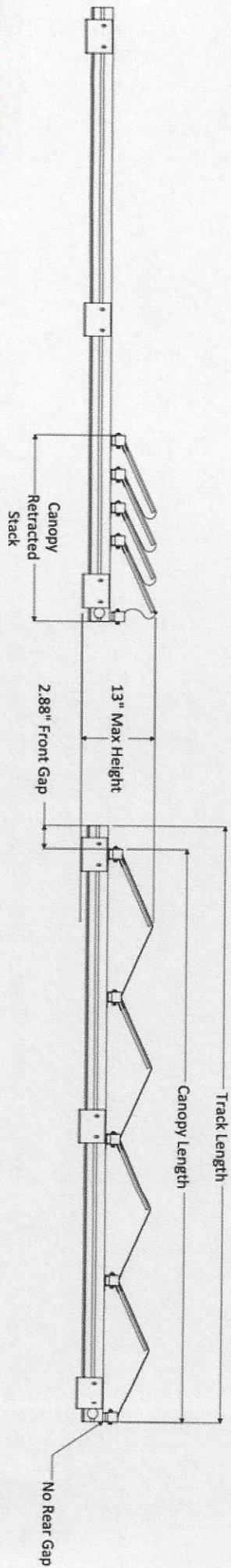

## MOTOR SIZES

2A	120/60/50 V GFI
3-Prong (Grounded) Connection Required	

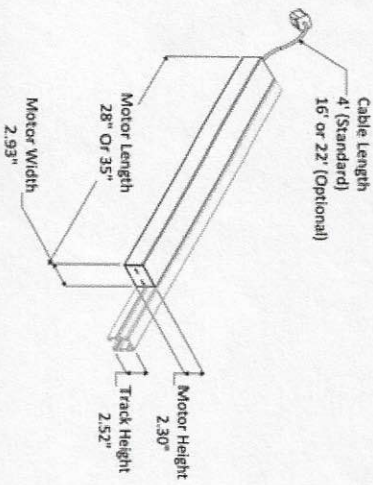

\* SHARING A POWER SOURCE WITH OTHER DEVICES MAY CAUSE A DROP IN PERFORMANCE. FOR BEST RESULTS DO NOT RUN ANY OTHER HIGH POWERED EQUIPMENT FROM THE SAME SOURCE

# MOUNTING EXAMPLES

## Parallel To Rafter

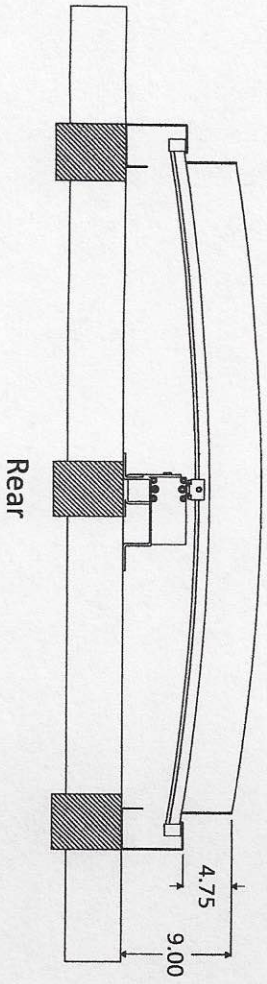

Rear

## Perpendicular To Rafters TAVARZIA

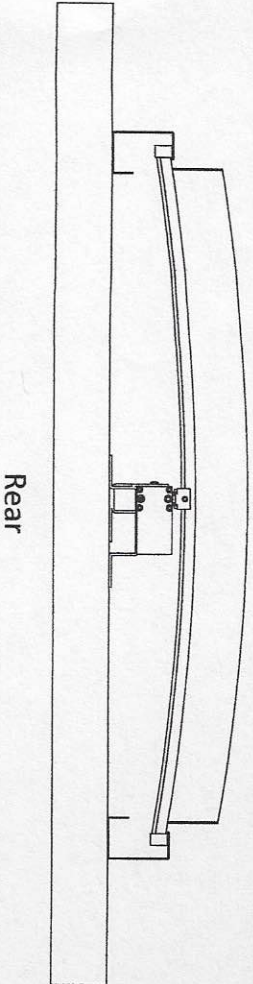

Rear

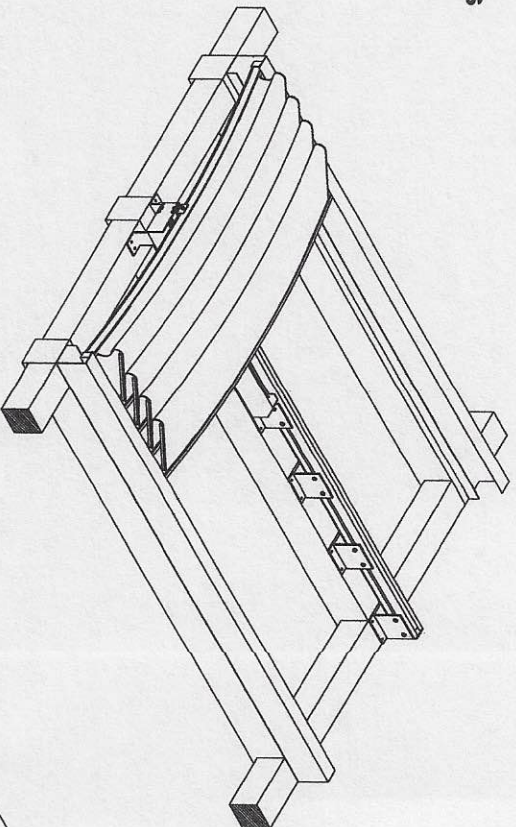

Max Rafter Spacing 3'

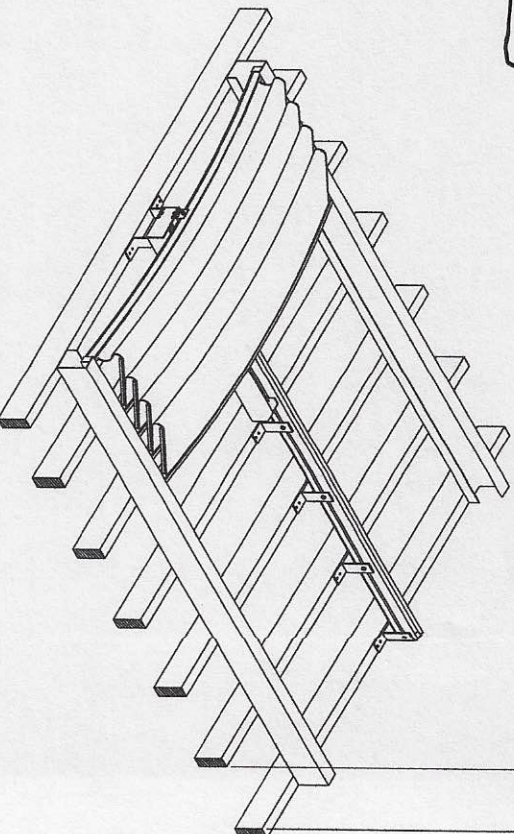

ShadeFX™

Notice: All drawings, designs, details, inventions, and development covered hereby are confidential, proprietary, and copyrighted by ShadeFX Canopies Inc., which reserves all patents, or other rights hereto. Materials may not be used, copied, or duplicated, in whole or in part, without the expressed written consent of ShadeFX Canopies Inc. Copyright © 2013, ShadeFX Canopies Inc. All Rights Reserved.